

APPLICATION NOTE

OJ DV Modbus protocol



Introduction

This document contains the Modbus addresses and registers which are available in the OJ DV. Modbus can access single addresses or several addresses simultaneously, either reading or writing 1-bit or 16-bit values.

Modbus connection

The OJ DV has four connectors for Modbus communication:

Three RJ12 connectors and one set of spring terminals.

On the strip of spring terminals for control signals (A/D I/O), there are three terminals for RS-485 connection, these are marked "A", "B" and "GND". See figure 1.

These RS-485 spring terminals are internally connected in parallel to the RS-485 pins in the RJ12 connectors marked "A" and "B". The RJ12 connector marked "C" is solely for the connection of external devices.

The three RJ12 connectors are marked "A", "B" and "C":

- "A": RS-485 interface connector, slave, +24VDC voltage supply in connector, for connection of a hand terminal OJ-DV-HMI-35T, etc.
- "B": RS-485 interface connector, slave, no voltage supply in connector, for connection of a PC, OJ-DV-PC-Tool etc.
- "C": Modbus connector, master, +24VDC voltage supply in connector (V+), for connection of an external device, e.g. PTH/VOC, OJ-DV-HMI-35T (in passive mode).

Figure 1

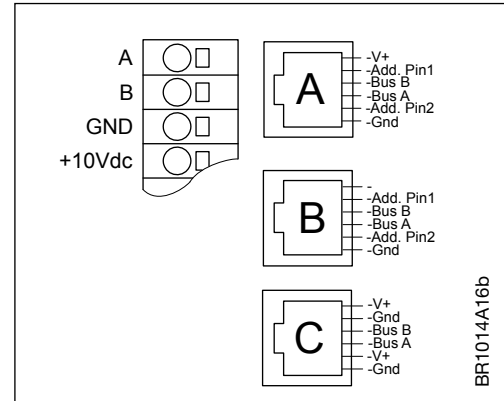

RS-485 interface connection cable

The following can be used for the Modbus communication cable:

- Round communication cable, which should be connected to the OJ DV terminals marked "A" and "B".
- Ribbon/telecom cable, 6-core, unshielded, 30 AWG, 0.066 mm² or similar ribbon cable.



Note

If ribbon/telecom cable is used, RJ12 connectors must be attached to both ends of the cable using a special-purpose tool.



Note

IMPORTANT! The RJ12 connectors must be attached to both ends in such a way that the two connectors follow the same sequence of wire colours in the cable. See figure 2.

Figure 2

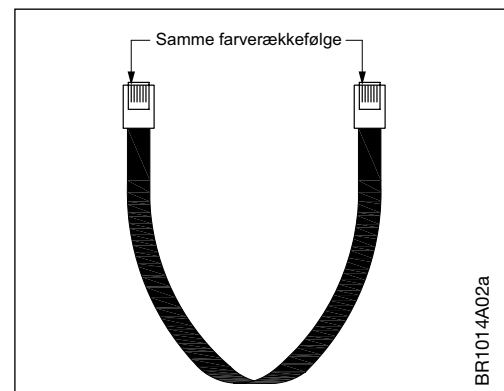

Modbus register types:

Modbus Type	Description	Reference
Coil Status (R/W)	Discrete Output	0x
Input Status (R)	Discrete Input	1x
Input Register (R)	16-bit Input Register	3x
Holding Register (R/W)	16-bit Output Register	4x

R=Read only

R/W = Read / Write









Supported Modbus commands

Function code	Description
1	Read Coil Status
2	Read Input Status
3	Read Holding Registers
4	Read Input Registers
5	Force Single Coil
6	Preset Single Registers
8	Diagnostics. Sub-function 00 Only - Return Query Data (loop back).
15	Force Multiple Coils
16	Preset Multiple Registers

Modbus addressing

Modbus addressing of the OJ DV controls can be accomplished in three different ways.

- Via the addressing pins of connector "A" or "B" (Add. Pin 1 + Add. Pin 2) – see figure 1 for pin location. The addressing pins can be used to assign the OJ DV controls the address range: 0x36 (dec.54), 0x37 (dec.55), 0x38 (dec.56) and 0x39 (dec.57), see table 1.

Pin.no. \ Add.	0X36 (54 dec)	0X37 (55 dec)	0X38 (56 dec)	0X39 (57 dec)
Add.Pin1				
Add.Pin2				

 = No connection between "GND" and Add.Pin1/ Add.Pin2

 = Connection between "GND" and Add.Pin1/ Add.Pin2

- Via OJ-Air2 FanIO through connector "B" (see instructions for OJ-Air2 FanIO).
- Via the OJ-DV-HMI-35T menu (see instructions for OJ-DV-HMI-35T).
- Via the OJ-DV-PC-Tool by writing to Modbus Holding Register 4x0017 (see instructions for OJ-DV-PC-Tool)

Communication parameters

Communication parameters can be set using OJ-DV-HMI-35T or via the OJ-DV-PC-Tool. For factory settings and setting ranges, see table 2.

	Range	Unit	Factory setting	Alternative factory settings:
Address	0-247	n/a	54 dec.	0 dec.
Baud rate	9.600, 19.200, 38.400, 57.600, 115.200	bps	38.400	115.200
Parity	None, even, odd	n/a	None	Even
Stop bit(s)	1, 2	n/a	1	1
Communication timeout	0-240	Sec.	10	10

n/a=not applicable

Contact OJ Electronics A/S for additional information.

Values in this protocol are to be changed at your own risk.

It is your own responsibility that changes of values and settings, do not cause any overload or damage to the product, motor or fan.

Coil Stat Bits – Available Coil Stat Bits are shown in table 3 below.

Standard Modbus (RTU)

Coil Stat Bits: 23 (R/W)

0x01: Read

0x05: Write Single Coil (NOTE: ON => output value = 0xFF00)

0x0F: Write Multiple Coils

Table 3				
Register	Address	Function	Range	Active state
0x0001	0	Motor ON/OFF	0 - 1	1 = ON
0x0002	1	Reset Alarms	0 - 1	1 = Reset
0x0004	3	FireMode	0 - 1	1 = Active
0x0006	5	Rotation	0 - 1	1 = CW
0x0007	6	Disable V_Ripple protection	0 - 1	1 = Disable
0x0008	7	Control mode	0 - 1	0 = Modbus, 1 = 0-10V
0x0009	8	Use alternate comm. settings	0 - 1	1 = Alternate
0x0010	9	Autodetect communication	0 - 1	1 = Enable
0x0011	10	Analog start signal	0 - 1	1 = Enable
0x0012	11	Invert analog speed input	0 - 1	1 = Invert
0x0013	12	Allow using Field Weakening	0 - 1	1 = Allow FW
0x0014	13	Allow using Brake Chopper	0 - 1	1 = Allow BC
0x0015	14	Allow using Cooling Fan	0 - 1	1 = Allow Fan
0x0016	15	3 x 230V config	0 - 1	0 = Voltage values from CCF 1 = Fixed values for 3 x 230V
0x0017	16	1V start voltage	0 - 1	0 = Start @ 2V 1 = Start @ 1V
0x0018	17	Very High Switch Frequency	0 - 1	0 = 8 kHz as "HI SF" 1 = 10 kHz as "HI SF"
0x0019	18	Write protect config	0 - 1	0 = Allow change via Modbus 1 = "Lock" configuration
0x0020	19	Clear PowerLog (Wh, kWh, MWh)	0 - 1	1 = Clear Power Log
0x0021	20	Motor output off	0 - 1	1 = Keep motor output off
0x0022	21	Show alarm-type with LED-blink	0 - 1	1 = Use blink to show alarm
0x0023	22	Autodetect Control mode	0 - 1	1 = Analog control with temporary Modbus override
0x0024	23	Set Output Pin (If Output Cfg=5)	0 - 1	0 = Output "Low", 1 = "High"
0x0031	30	Analog Firemode	0 - 1	1 = active
0x0033	32	Set Relay 1 (If IO_Opt1 config=5)	0 - 1	0 = Relay1 Closed, 1 = Open
0x0034	33	Set Relay 2 (If IO_Opt2 config=5)	0 - 1	0 = Relay2 Closed, 1 = Open
0x0035	34	Firmware Locked	0 - 1	1 = Locked
0x0036	35	BACnet Enable	0 - 1	1 = Enabled
0x0037	36	AutoDetect BACnet	0 - 1	1 = Enabled

Input Stat Bits – Available Input Stat Bits are shown in table 4 below.

Input Stat Bits: 29 (R)

0x02: Read

Register	Address	Function	Range	Active state
1x0001	0	V LO Alarm	0 - 1	1 = Alarm
1x0002	1	V HI Alarm	0 - 1	1 = Alarm
1x0003	2	I HI Alarm (Motor out short)	0 - 1	1 = Alarm
1x0004	3	Temperature High	0 - 1	1 = Warning
1x0005	4	Input Phase Error	0 - 1	1 = Warning
1x0006	5	Rotor Blocked	0 - 1	1 = Alarm
1x0007	6	Current Limit	0 - 1	1 = Warning
1x0008	7	Voltage Limit	0 - 1	1 = Warning
1x0009	8	Rotor Direction	0 - 1	1 = Alarm
1x0010	9	EEPROM Error	0 - 1	1 = Warning
1x0011	10	Internal Stop	0 - 1	1 = Alarm (Stop)
1x0012	11	Earth fault (H5 only)	0 - 1	1 = Alarm
1x0013	12	Brake Chopper Fault	0 - 1	1 = Warning
1x0014	13	Motor Phase Error	0 - 1	1 = Alarm
1x0015	14	Communication error MOC	0 - 1	1 = Alarm
1x0016	15	V Ripple	0 - 1	1 = Warning
1x0017	16	Digital Input 1	0 - 1	1 = HI
1x0018	17	Digital Input 2	0 - 1	1 = HI
1x0019	18	Ext. 24V supply overload	0 - 1	1 = Overload
1x0020	19	MOC in bootloader	0 - 1	1 = Alarm
1x0021	20	Digital Input 3 (IOM)	0 - 1	1 = HI*
1x0022	21	Digital Input 4 (IOM)	0 - 1	1 = HI*
1x0023	22	Communication error IOM	0 - 1	1 = Warning*
1x0024	23	Motor Overheat (IOM)	0 - 1	1 = Alarm
1x0025	24	Windmilling	0 - 1	1 = Warning
1x0026	25	Rotation OK	0 - 1	1 = OK
1x0027	26	IO Config mismatch	0 - 1	1 = Warning
1x0028	27	Config write attempt	0 - 1	1 = Detected
1x0029	28	Unsaved UserData	0 - 1	1 = Unsaved

*: Only if one of the IOM output functions is enabled

Input Registers – Available Input Registers are shown in table 5 & 6 below.

Input Registers: 34 (R)

0x04: Read

Table 5							
Register	Address	Function	Range	EC-config (PM)		FC-config (AC)	
				Resolution	Unit	Resolution	Unit
3x0001	0	Drive Type	1000 - 65535	1	-	1	-
3x0002	1	AOC SW version	0 - 65535	0.01	-	0.01	-
3x0003	2	MOC SW version	0 - 65535	0.01	-	0.01	-
3x0004	3	PrcOut	0 - 10000	0.01	%	0.01	%
3x0005	4	RPMOut	0 - 3000	1	RPM	0.01	Hz
3x0006	5	Intern Temp	-5000 - 15000	0.01	°C	0.01	°C
3x0007	6	V In (RMS)	0 - 500	1	V	1	V
3x0008	7	I Out	0 - 65535	1	mA	1	mA
3x0009	8	Power In (filtered)	0 - 20000	1	W	1	W
3x0010	9	I Ripple	0 - 65535	1	mA	1	mA
3x0011	10	Operation Minutes	0 - 1439	1	Min.	1	Min.
3x0012	11	Operation Day	0 - 9999	1	Day	1	Day
3x0013	12	V Ripple	0 - 500	1	V	1	V
3x0014	13	Config file variant	AA - ZZ	2 ASCII characters		2 ASCII characters	
3x0015	14	Config file version	100 - 32000	0.01	-	0.01	-
3x0016	15	ExternSet	0 - 10000	1	mV	1	mV
3x0017	16	Power Supply	0 - 600	1	V	1	V
3x0018	17	OverVoltageCount	0 - 65535	1	-	1	-
3x0019	18	AOC SW variant	-	-	-	-	-
3x0020	19	AOC Boot SW	0 - 65535	0.01	-	0.01	-
3x0021	20	MOC Boot SW	0 - 65535	0.01	-	0.01	-
3x0022	21	Motor Cfg. Var.	0 - 65535	1	-	1	-
3x0023	22	Motor Cfg. Ver.	0 - 65535	0.01	-	0.01	-
3x0024	23	Fan Cfg. Var.	0 - 65535	1	-	1	-
3x0025	24	Fan Cfg. Ver.	0 - 65535	0.01	-	0.01	-
3x0026	25	User Data Var.	0 - 65535	1	-	1	-
3x0027	26	User Data Ver.	0 - 65535	0.01	-	0.01	-
3x0028	27	IOM SW version	0 - 65535	0.01	-	0.01	-
3x0029	28	V DC Bus (Peak)	0 - 800	1	V	1	V
3x0030	29	V Motor (Peak)	0 - 500	1	V	1	V
3x0031	30	Power In (unfilterd)	0 - 15000	1	W	1	W
3x0032	31	Power Consumpt.	0 - 999	1	Wh	1	Wh
3x0033	32	Power Consumpt.	0 - 999	1	kWh	1	kWh
3x0034	33	Power Consumpt.	0 - 65535	1	MWh	1	MWh
3x0039	38	HMI Device status	0 - 65525	-	-	-	-
3x0040	39	HMI SW version	100 - 32000	0.01	-	0.01	-
3x0041	40	IOM Ain2 current	0 - 20000	1	µA	1	µA
3x0042	41	BACnetSWVersion	0-65535	0.01	-	0.01	-

Input Registers: 18 (R)

0x04: Read

Register	Address	Function	Resolution	Resolution	Unit
3x8193	8192	Production week	0100-5399	1	WWYY
3x8194	8193	Production order number LO	0-9999	1	-
3x8195	8194	Production order number HI	0-9999	10000	-
3x8196	8195	Serial number of batch	0-65535	1	-
3x8197	8196	Product name length + Char0	0-65535	-	2 x ACSII Char
3x8198	8197	Char1 + Char2	0-65535	-	2 x ACSII Char
3x8199	8198	Char3 + Char4	0-65535	-	2 x ACSII Char
3x8200	8199	Char5 + Char6	0-65535	-	2 x ACSII Char
3x8201	8200	Char7 + Char8	0-65535	-	2 x ACSII Char
3x8202	8201	Char9 + Char10	0-65535	-	2 x ACSII Char
3x8203	8202	Char11 + Char12	0-65535	-	2 x ACSII Char
3x8204	8203	Char13 + Char14	0-65535	-	2 x ACSII Char
3x8205	8204	Char15 + Char16	0-65535	-	2 x ACSII Char
3x8206	8205	Char17 + Char18	0-65535	-	2 x Ascii char
3x8207	8206	Char19 + Char20	0-65535	-	2 x ACSII Char
3x8208	8207	Char21 + Char22	0-65535	-	2 x ACSII Char
3x8209	8208	Char23 + Char24	0-65535	-	2 x ACSII Char
3x8210	8209	Char25 + Char26	0-65535	-	2 x ACSII Char
3x8211	8210	Char27 + "NULL"	0-65535	-	2 x ACSII Char

Holding Registers – Available Holding Registers are shown in table 7 below.

Holding Registers: 40 (R/W)

0x03: Read

0x06: Write Single

0x10: Write Multiple

			EC-configuration			FC-configuration		
Register	Address	Function	Range	Resolution	Unit	Range	Resolution	Unit
4x0001	0	Setpoint / PrcSet	0 - 10000	0.01	%	0 - 10000	0.01	%
4x0002	1	Min. RPM	0 - 5000	1	RPM	0 - 12000	0.01	Hz
4x0003	2	Max. RPM	0 - 5000	1	RPM	0 - 12000	0.01	Hz
4x0004	3	UpRampTime	15 - 240	1	Sec.	15 - 240	1	Sec.
4x0005	4	DownRampTime	15 - 240	1	Sec.	15 - 240	1	Sec.
4x0008	7	Max I Out	0 - ?	1	mA	1000 - 65000	1	mA
4x0009	8	Boost I Out	n/a	1	mA	1000 - 65000	1	mA
4x0011	10	SwitchMode	0	AutoSpeed		0	AutoSpeed	
			1	4	kHz	1	4	kHz
			2	8	kHz	2	8	kHz
			3	AutoTemp		3	AutoTemp	
4x0012	11	U minHz	n/a	n/a	n/a	0 - 250	1	V
4x0013	12	Freq Umax	n/a	n/a	n/a	0 - 12000	0.01	Hz
4x0014	13	AutoSF_Change	0 - 10000	0.01	%	0 - 10000	0.01	%
4x0015	14	ExpSet	n/a	n/a	n/a	0 - 200	1	-
4x0016	15	Drive Type	0, 100 - 65000	1	-	1 - 99	1	-

"?"= Value depends on hardware variant

"n/a"= not applicable

APPLICATION NOTE OJ DV Modbus protocol

Continued table 7			Common for EC (PM) & FC (AC) configuration		
Register	Address	Function	Range / Value	Resolution / Option	Unit
4x0017	16	Modbus ID	1 - 247	1	-
4x0018	17	ModbusResponseDelay	0 - 200	1	ms
4x0020	19	Number of retries	-1 - 100	1	-
4x0022	21	CommTimeout	0 - 240	1	Sec.
4x0023	22	CommRate	0	9600	bps
			1	19200	bps
			2	38400	bps
			3	115200	bps
			4	57600	bps
4x0024	23	Parity	0	None	-
			1	Odd	-
			2	Even	-
4x0025	24	Stop Bits	0	INVALID	-
			1	1	-
			2	2	-
4x0026	25	DigIn1 config	0	Disabled	-
			1	Start/stop	-
			2	AlarmReset	-
			3	MB_IDs_2	-
			4	Invert 0-10V (open = inverted)	-
			5	Rotation	-
			6	Firemode	-
			7	Motor Overheat	-
			8	Invert 0-10V (open = not inverted)	-
			9	Motor output off	-
			10	Modbus Disable	-
			11	FiremodeMax	-
			12	Digital Dual Speed	-
			13	Modbus Enable	-
			14	Modbus ID Offset 1	-
			15	Modbus ID Offset 2	-
			16	Modbus ID Offset 10	-
			17	FiremodeMax with disable	-
4x0027	26	DigIn2 config	0	Disabled	-
			1	Start/stop	-
			2	AlarmReset	-
			3	MB_IDs_2	-
			4	Invert 0-10V (open = inverted)	-
			5	Rotation	-
			6	Firemode	-
			7	Motor Overheat	-
			8	Invert 0-10V (open = not inverted)	-
			9	Motor output off	-
			10	Modbus Disable	-
			11	FiremodeMax	-
			12	Digital Dual Speed	-
			13	Modbus Enable	-
			14	Modbus ID Offset 1	-
			15	Modbus ID Offset 2	-
			16	Modbus ID Offset 10	-
			17	FiremodeMax with disable	-
4x0028	27	DigOut config	0	Disabled	-

Continued table 7			Common for EC (PM) & FC (AC) configuration		
Register	Address	Function	Range / Value	Resolution / Option	Unit
			1	TachoOut	-
			2	RunningStart	-
			3	AlarmOut (NO)	-
			4	RunningSpin	-
			5	Set output status via coil stat 24	-
			6	Single Error Alarm	-
			7	AlarmOut (NC)	-
			9	AlarmOut or Firemode	-
			10	RunningStart NO Firemode	-
			11	RunningSpin NO Firemode	-
			4x0029	28	MotorConfigVar
4x0030	29	FanConfigVar	0 - 65534	1	-
4x0031	30	DigIn3 config (IOM)	0	Disabled	-
			1	Start/stop	-
			2	AlarmReset	-
			3	Disabled	-
			4	Invert 0-10V	-
			5	(open = inverted)	-
			6	Rotation	-
			7	Firemode	-
			8	N/A	-
			9	Invert 0-10V	-
			10	(open = not inverted)	-
			11	Motor output off	-
			12	Modbus Disable	-
			13	Modbus Enable	-
			14	Modbus ID Offset 1	-
			15	Modbus ID Offset 2	-
			16	Modbus ID Offset 10	-
			17	FiremodeMax with disable	-
4x0032	31	DigIn4 config (IOM)	0	Disabled	-
			1	Start/stop	-
			2	AlarmReset	-
			3	Disabled	-
			4	Invert 0-10V (open = inverted)	-
			5	Rotation	-
			6	Firemode	-
			7	N/A	-
			8	Invert 0-10V (open = not inverted)	-
			9	Motor output off	-
			10	Modbus Disable	-
			11	FiremodeMax	-
			12	Digital Dual Speed	-
			13	Modbus Enable	-
			14	Modbus ID Offset 1	-
			15	Modbus ID Offset 2	-
			16	Modbus ID Offset 10	-
			17	FiremodeMax with disable	-
4x0033	32	IO_Opt1 config (IOM)	0	Disabled	-
			1	N/A	-
			2	RunningStart	Output
			3	AlarmOut	Output
			4	RunningSpin	Output

Continued table 7			Common for EC (PM) & FC (AC) configuration		
Register	Address	Function	Range / Value	Resolution / Option	Unit
			5	Set output status via coil stat 0x0024	Output
			6	Single Error Alarm	Output
			7	Alarm NC	-
			9	AlarmOut or Firemode	-
			10	RunningStart NO Firemode	-
			11	RunningSpin NO Firemode	-
			100	Disabled	-
			101	Start/Stop	Input
			102	AlarmReset	Input
			103	Disabled	Input
			104	Invert 0-10V (open = inverted)	Input
			105	Rotation	Input
			106	Firemode	Input
			107	N/A	-
			108	Invert 0-10V (open = not inverted)	Input
			109	Motor output off	Input
			110	N/A	-
			111	FiremodeMax	Input
			112	Digital Dual Speed	Input
			113	Modbus Enable	-
			114	Modbus ID Offset 1	-
			115	Modbus ID Offset 2	-
			116	Modbus ID Offset 10	-
			117	FiremodeMax with disable	-
4x0034	33	IO_Opt2 config (IOM)	0	Disabled	-
			1	N/A	-
			2	RunningStart	Output
			3	AlarmOut	Output
			4	RunningSpin	Output
			5	Set output status via coil stat 24	Output
			6	Single Error Alarm	Output
			7	Alarm NC	-
			9	AlarmOut or Firemode	-
			10	RunningStart NO Firemode	-
			11	RunningSpin NO Firemode	-
			100	Disabled	-
			101	Start/Stop	Input
			102	AlarmReset	Input
			103	Disabled	Input
			104	Invert 0-10V (open = inverted)	Input
			105	Rotation	Input
			106	Firemode	Input
			107	N/A	-
			108	Invert 0-10V (open = not inverted)	Input
			109	Motor output off	Input
			110	N/A	-
			111	FiremodeMax	Input

APPLICATION NOTE OJ DV Modbus protocol

Continued table 7			Common for EC (PM) & FC (AC) configuration		
Register	Address	Function	Range / Value	Resolution / Option	Unit
			112	Digital Dual Speed	Input
			113	Modbus Enable	-
			114	Modbus ID Offset 1	-
			115	Modbus ID Offset 2	-
			116	Modbus ID Offset 10	-
			17	FiremodeMax with disable	-
4x0035	34	AnalogOut1 config (IOM)	0	Disabled	-
			1	ActSpeed	-
			2	TBD	-
4x0036	35	Thermistor config (IOM)	0	Disabled	-
			1	Motor Overheat PTC	-
			2	TBD	-
4x0037	36	AnalogIn2 config (IOM)	0	Disabled	-
			1	SpeedControl 4 - 20 mA	-
			2	TBD	-
4x0038	37	Thermistor threshold	1 - 65000	1	Ω
4x0039	38	Max Windmilling Time	0 - 65000	1	Sec
4x0049	48	Jumping Frequency_Low 1 or Dual Speed 1	MinRPM – MaxRPM	1	RPM
4x0050	49	Jumping Frequency_High 1 or Dual Speed 2	MinRPM – MaxRPM	1	RPM
4x0051	50	Jumping Frequency_Low 2	MinRPM – MaxRPM	1	RPM
4x0052	51	Jumping Frequency_High 2	MinRPM – MaxRPM	1	RPM
4x0053	52	Jumping Frequency_Low 3 or Firemode Max speed	MinRPM – MaxRPM	1	RPM
4x0054	53	Jumping Frequency_High 3	MinRPM – MaxRPM	1	RPM
4x0057	56	BacnetMAC	0-127		-
4x0058	57	BacnetMaxMaster	1-127		-
4x0059	58	BacnetDeviceObjectInstance_Low	0- 4194302		-
4x0060	59	BacnetDeviceObjectInstance_High	(2^22-2)		-

"TBD"= To be done – for future use